

Metalwërks Sculpted frees designers to create iconic facades more easily and affordably than ever before by elevating three-dimensional wall panels to entirely new heights. This innovative dry-set rain screen system features three complementary and interchangeable wall panel design schemes that produce the boldest three-dimensional forms possible.

Additionally, for enhanced visual expression, the 100% solid metal system is engineered for easy integration with LED lighting and features opportunities to incorporate other ornamental design elements. Plus, Sculpted provides opportunities to incorporate integrated planters and irrigation for growing vegetation.

Whether Sculpted is incorporated throughout the entirety of the building envelope or used solely for accented or featured areas, such as an outdoor meeting space, the system easily interfaces with all other Metalwërks systems and alternative facade materials.

Sculpted may be installed over continuous masonry, concrete, or as the outer cladding in a wall assembly that incorporates continuous insulation and a suitable air and water barrier. Sculpted is also ideal for interior applications such as lobbies and atriums or any special gathering area.

Metalwërks can work with a design team to create other three-dimensional forms that meet your vision or design intent.



Minimal installs both horizontally and vertically. In a horizontal orientation, the panels can include optional continuous planter troughs for living walls. Optional LED lighting can also be integrated into these panels.

APPLICATIONS

- Architectural screen wall assemblies, walls for parking structures or monumental tower and/or facade features
- Prominent feature walls on the exterior facade facing publicly viewed elevations, using more economical Metalwërks wall systems on the less prominent walls
- Demising/privacy walls between residential unit balconies or pool/deck play level screen walls
- Interior lobby spaces in atria or clerestory spaces
- Exterior/Interior facades for large public spaces such as stadiums, hotels, convention centers, airports/transit centers
- Public gathering or convocation spaces at higher education facilities
- Greening wall surfaces and feature elements on green roof assemblies
- Kitchen/herb gardens for restaurants, bars, public plazas
- Lighted feature walls

DETAILS

- Manufactured from solid aluminum, stainless, or zinc plate with integral panel returns formed from a single piece of metal
- Solid aluminum and stainless steel: high resistance to denting and puncturing, ideal for high-traffic or abusive areas
- Fully mitered and welded corners ground smooth for seamless appearance
- 0.625" (15.8 mm) standard horizontal and vertical joint with variable options
- Adjustable furring to address variable construction tolerances and ensuring vertical sealing to air and water barrier, minimizing shims
- Concealed fastened using corrosion-resistant self-tapping screws
- Non-Combustible: minimal smoke or fuel contribution
- Avoids NFPA 285 complications by avoiding thermo-plastic cores
- All panel systems are reinforced/stiffened to resist deflection limits
- Aluminum: post-applied finishing for longterm performance and uniform aesthetic
- 100% recyclable with high percentage of post-consumer and industrial content, which may contribute to LEED credits
- Common panel platform for seamless integration with other Metalwërks wall systems

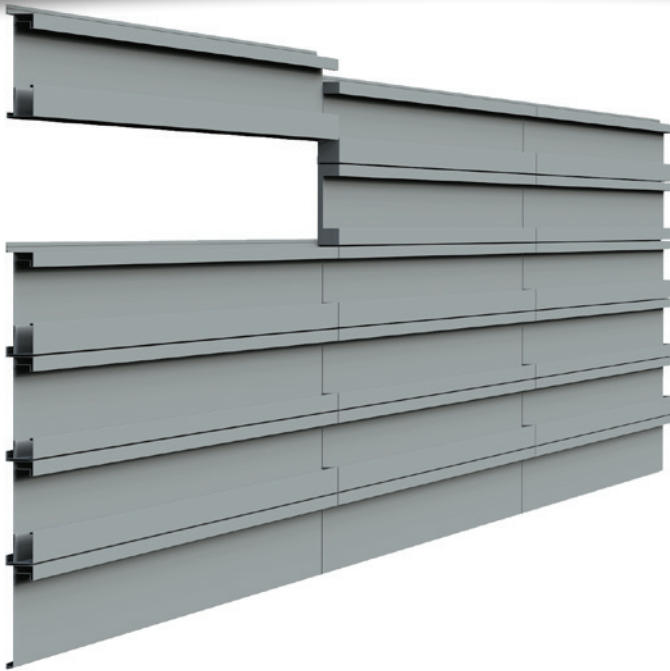

DESIGN OPTIONS

- Variable reveals: Horizontal 0.5" - 2" (12.7 mm - 50.8 mm); Vertical 0.25" - 6" (6.35 mm - 152.4 mm)
- Integrated LEDs
- Integrated planters and irrigation
- Unlimited color options for aluminum plate
- Options for #4, #6, #8, and non-directional finishes for stainless plate
- Matching perforated and louvered panels
- Optional back-cuts on formed panel edges for a sharper bend and crisper appearance

METAL SUBSTRATE AND FINISH OPTIONS

ALUMINUM

3003-H14 aluminum alloy-temper

Thickness: 0.125" (3.18 mm)

Finishes: Kynar®, architectural TGIC polyester powder coating, or anodized

STAINLESS STEEL

T304 or T316

Thickness: 18 gauge (0.05") (1.27 mm) standard, 16 gauge (0.063") (1.60 mm), 14 gauge (0.078") (1.98 mm), 12 gauge (0.101") (2.78 mm) options

Finishes: #4, #6, #8, and non-directional satin in smooth or custom embossed patterns

ZINC

Thickness: 0.079" (2 mm)

Finishes: Consult with Metalwërks for options

Zinc is a natural metal which has specific properties that will limit its use. It must be adequately drained, ventilated and weeped when used in exterior applications to prevent excessive corrosion. Please consult Metalwërks for the appropriate uses for your project design.

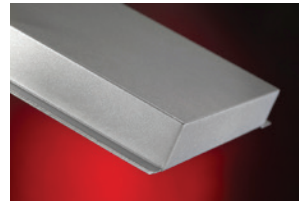

SHARP CORNER

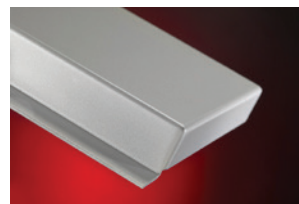

STANDARD CORNER

PANEL SIZES

Widths: Widths: 24" (610 mm) to 66" (1676 mm)*

Lengths: 24" (610 mm) to 160" (4,064 mm)*

Depth: 1.74" (44.2 mm) plus trough minimal

* Maximum panel size depends upon plate material, gauge, finish, and geometry

PANEL WEIGHT RANGE

(dependent upon gauge and geometry)

Aluminum: 4.9 lbs./ft²

Stainless Steel: 8.43 lbs./ft²

Zinc: 8.04 lbs./ft²

Ranges provided for clarification. Consult with Metalwërks for further options.

ACCESSORIES

Flashing: 0.040" (1.016 mm) thick to 0.063" (1.60 mm) aluminum

Coping: Wall copings may be produced with the same material as the wall panel system

Furring / Framing Channels: Engineered secondary supports to accommodate added dead loads

Fasteners: Type 304 stainless steel or cadmium-plated as recommended

Shims: High impact thermally-broken plastic shims to maintain co-planar surfaces

WARRANTY

Material & Workmanship: 1-year standard, with 2- or 5-year options

Finish Integrity: 10-year standard and up to 20-year for coated aluminum

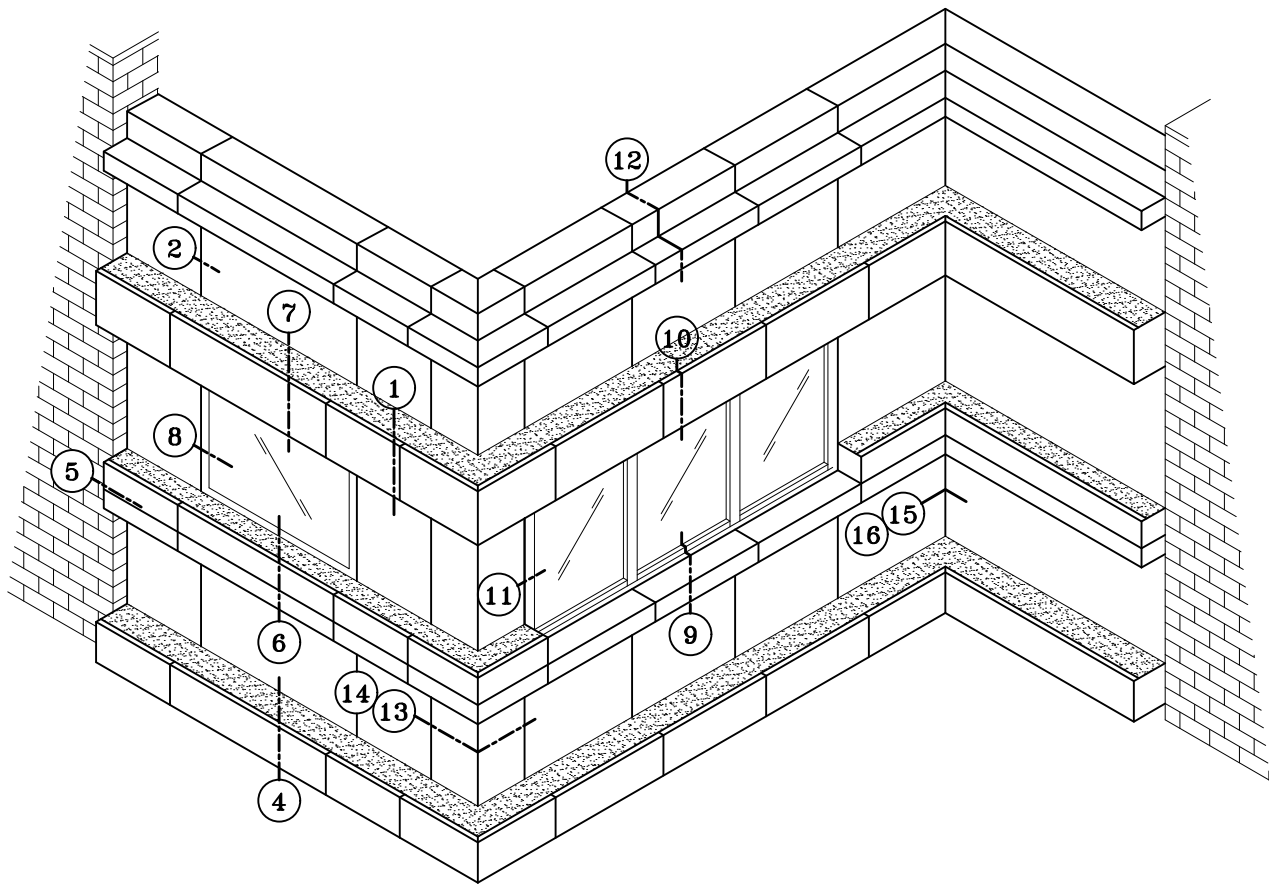
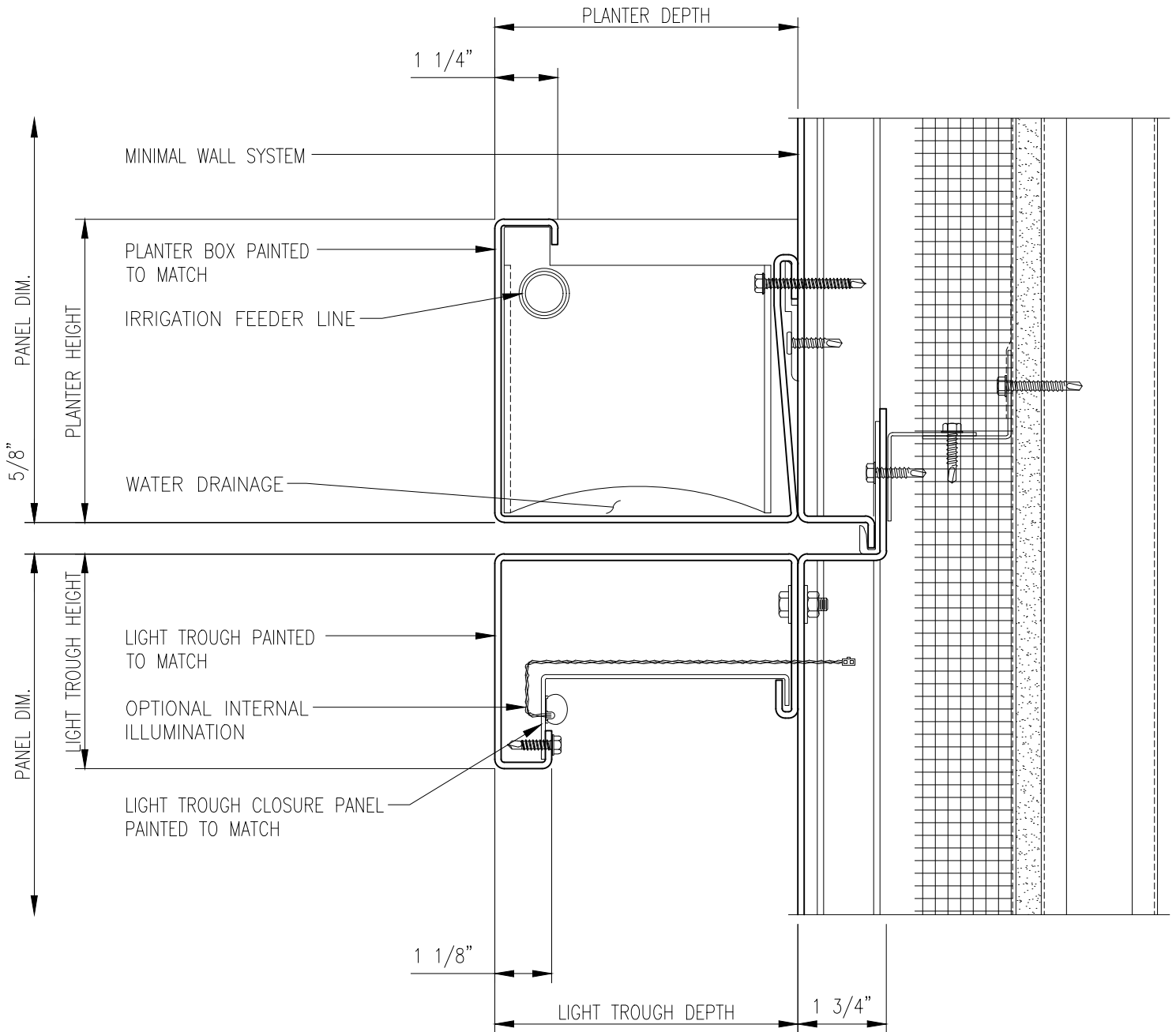

Table of Contents:

DETAIL DESCRIPTION

- 1 Horizontal Joint
- 2 Vertical Joint
- 3 Panel Stiffener
- 4 Panel Sill
- 5 Panel Jamb
- 6 Storefront Sill
- 7 Storefront Head
- 8 Storefront Jamb
- 9 Curtain Wall Sill
- 10 Curtain Wall Head
- 11 Curtain Wall Jamb
- 12 Coping
- 13 Outside Corner w/ Mitered Panel
- 14 Outside Corner w/ Corner Reveal
- 15 Inside Corner w/ Mitered Panel
- 16 Inside Corner w/ Corner Reveal

CONSULT WITH METALWERKS FOR
AVAILABLE PLANTER BOX SIZES



1) Horizontal Joint

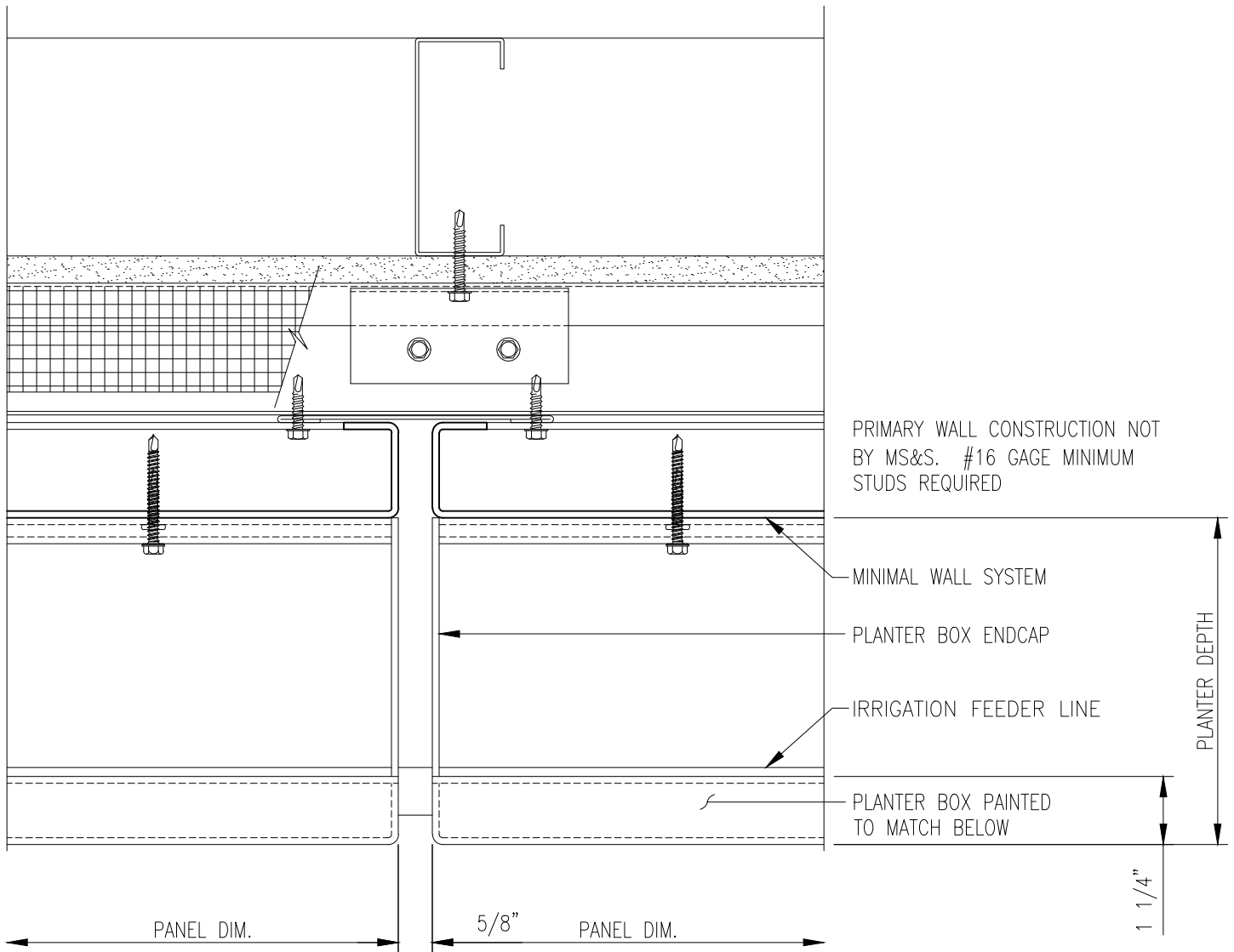

2) Vertical Joint

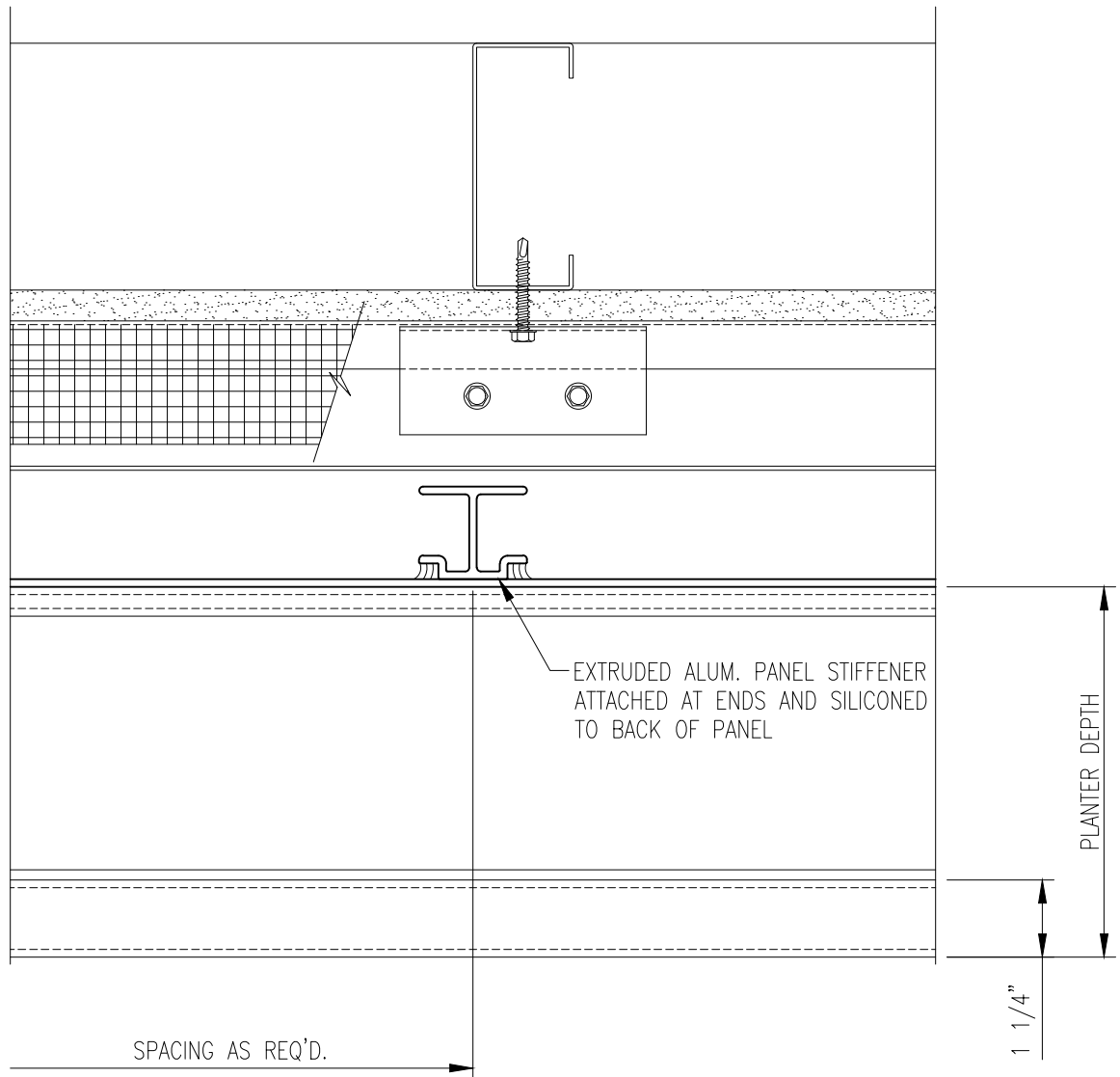

3) Panel Stiffener

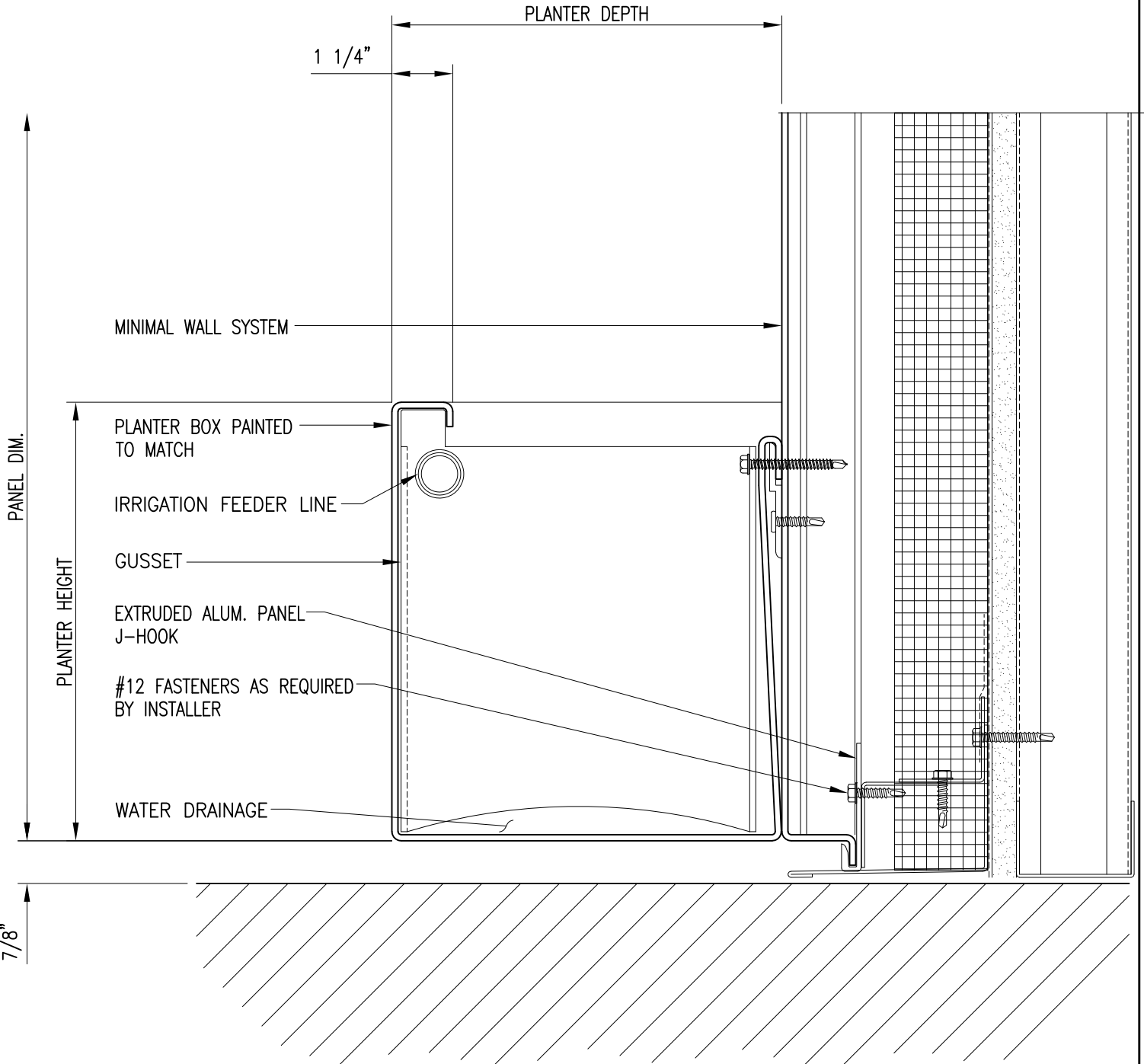

4) Panel Sill

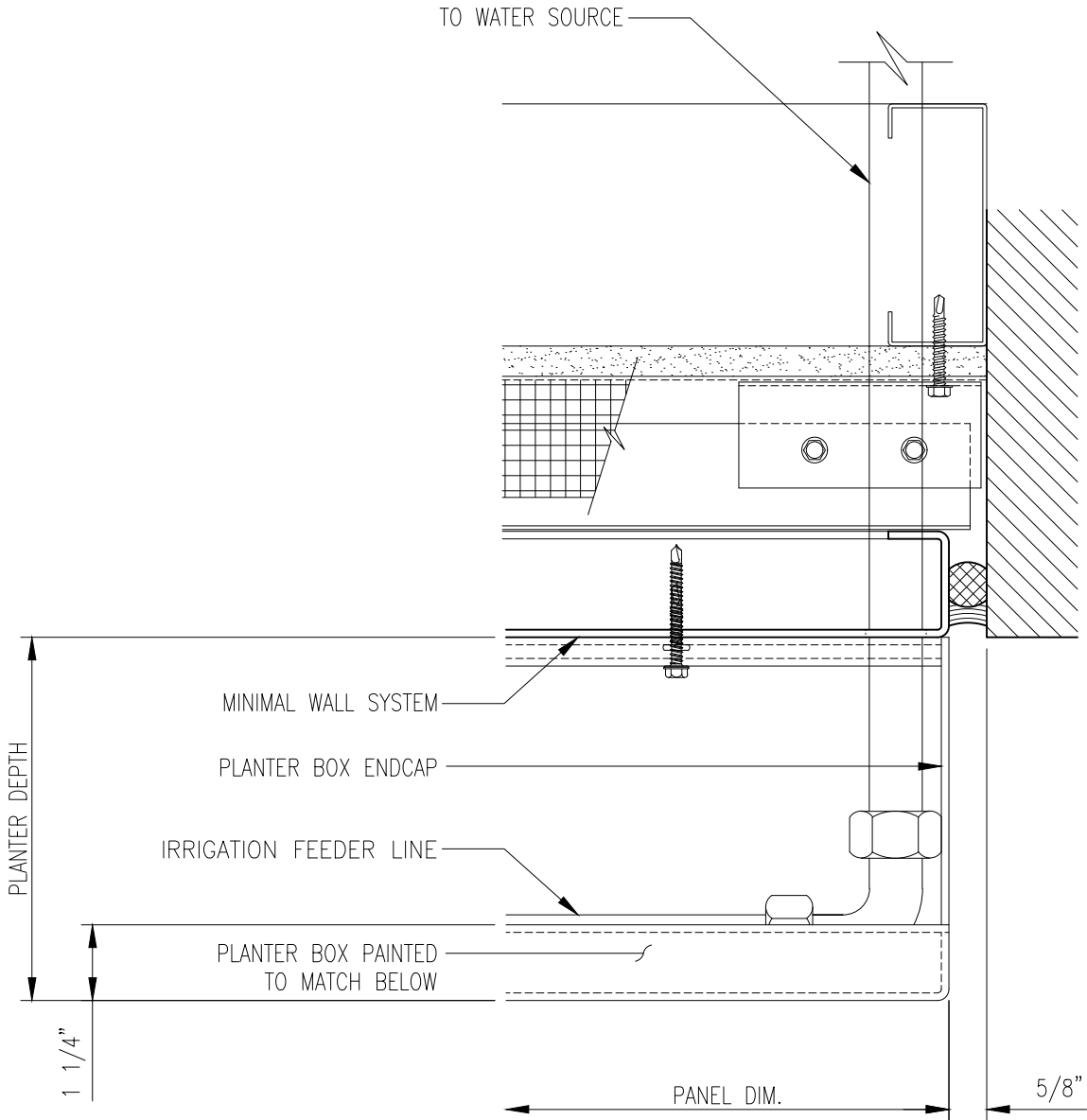

5) Panel Jamb

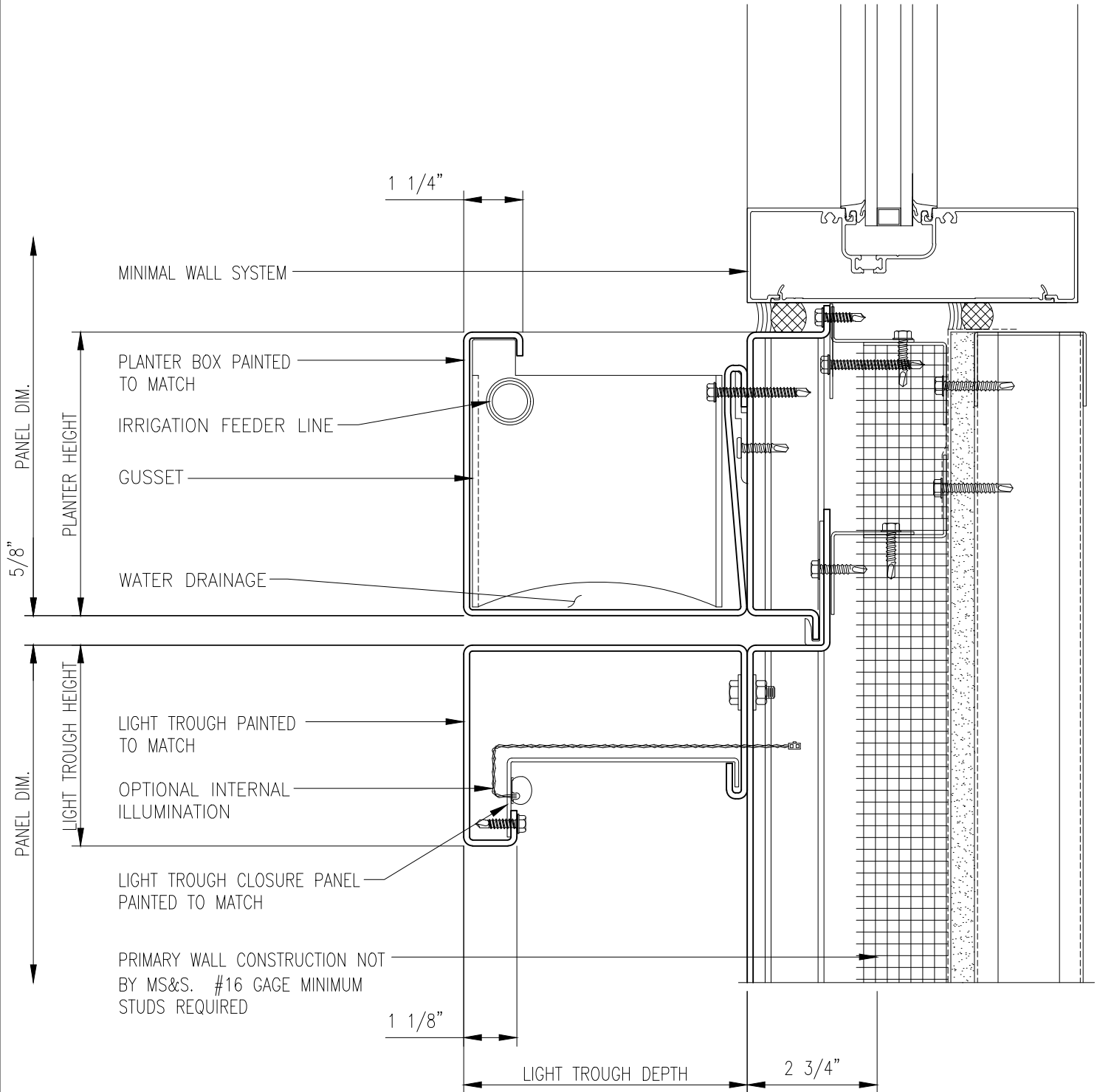

6) Storefront Sill

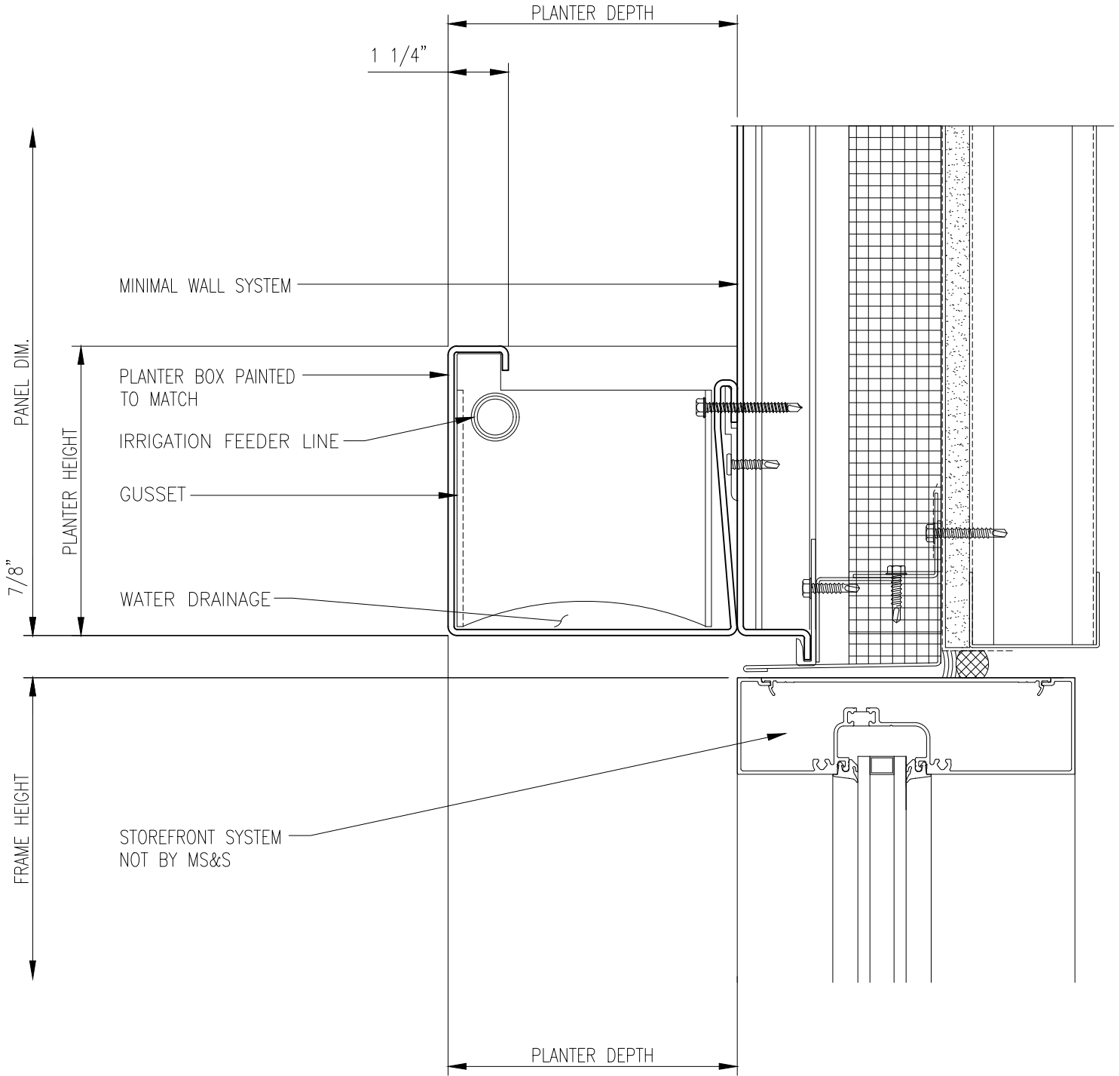

7) Storefront Head

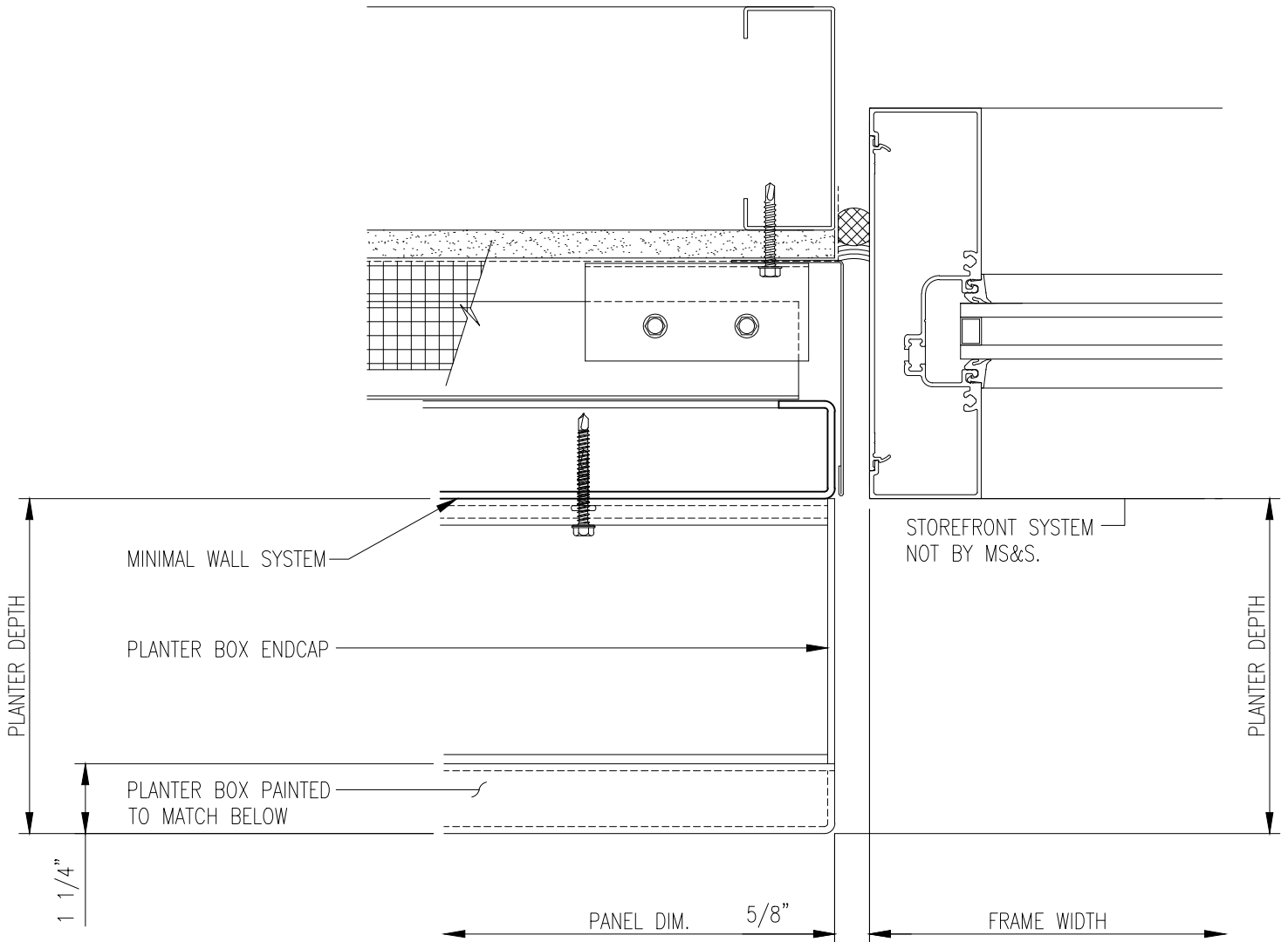

8) Storefront Jamb

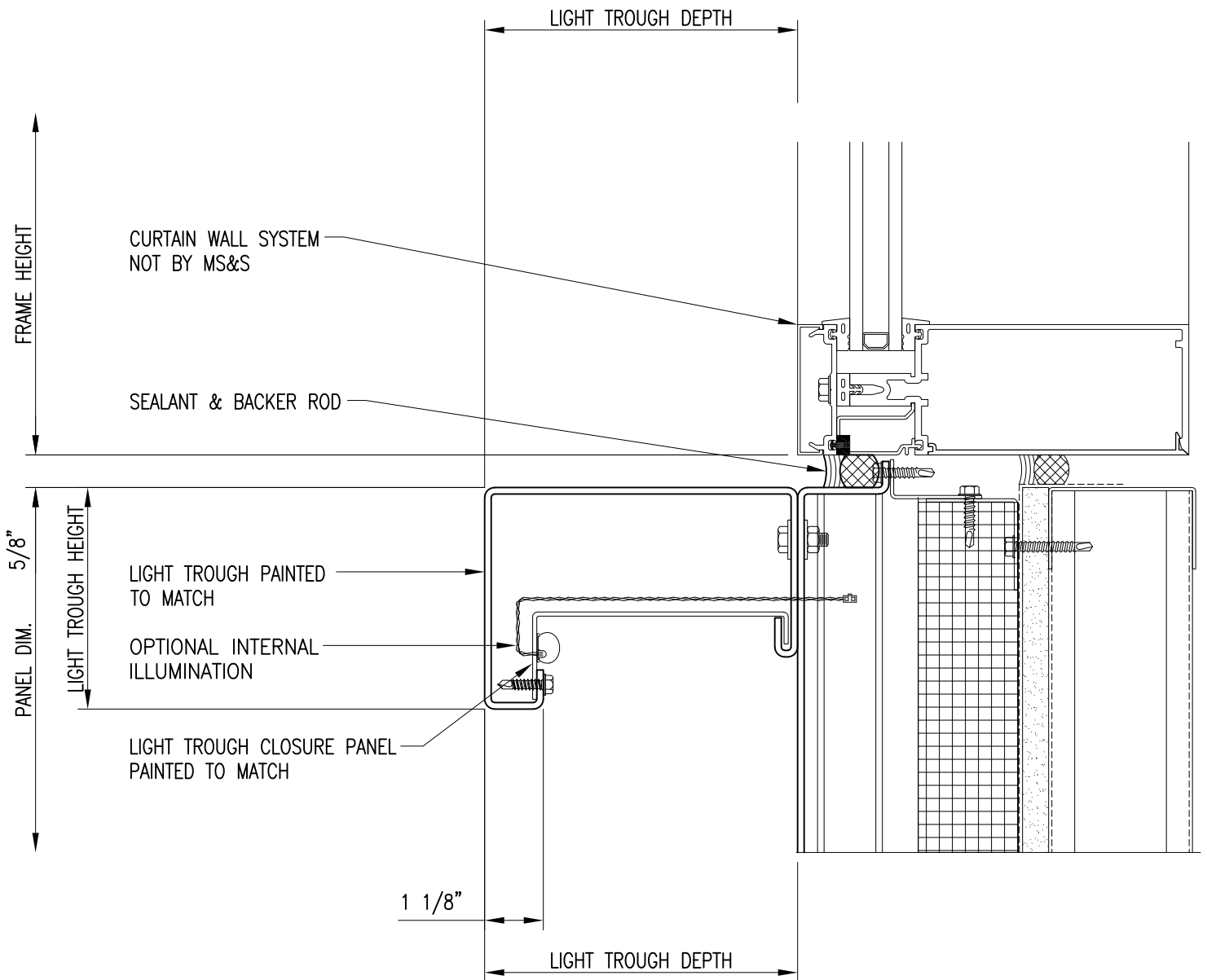

9) Curtain Wall Sill

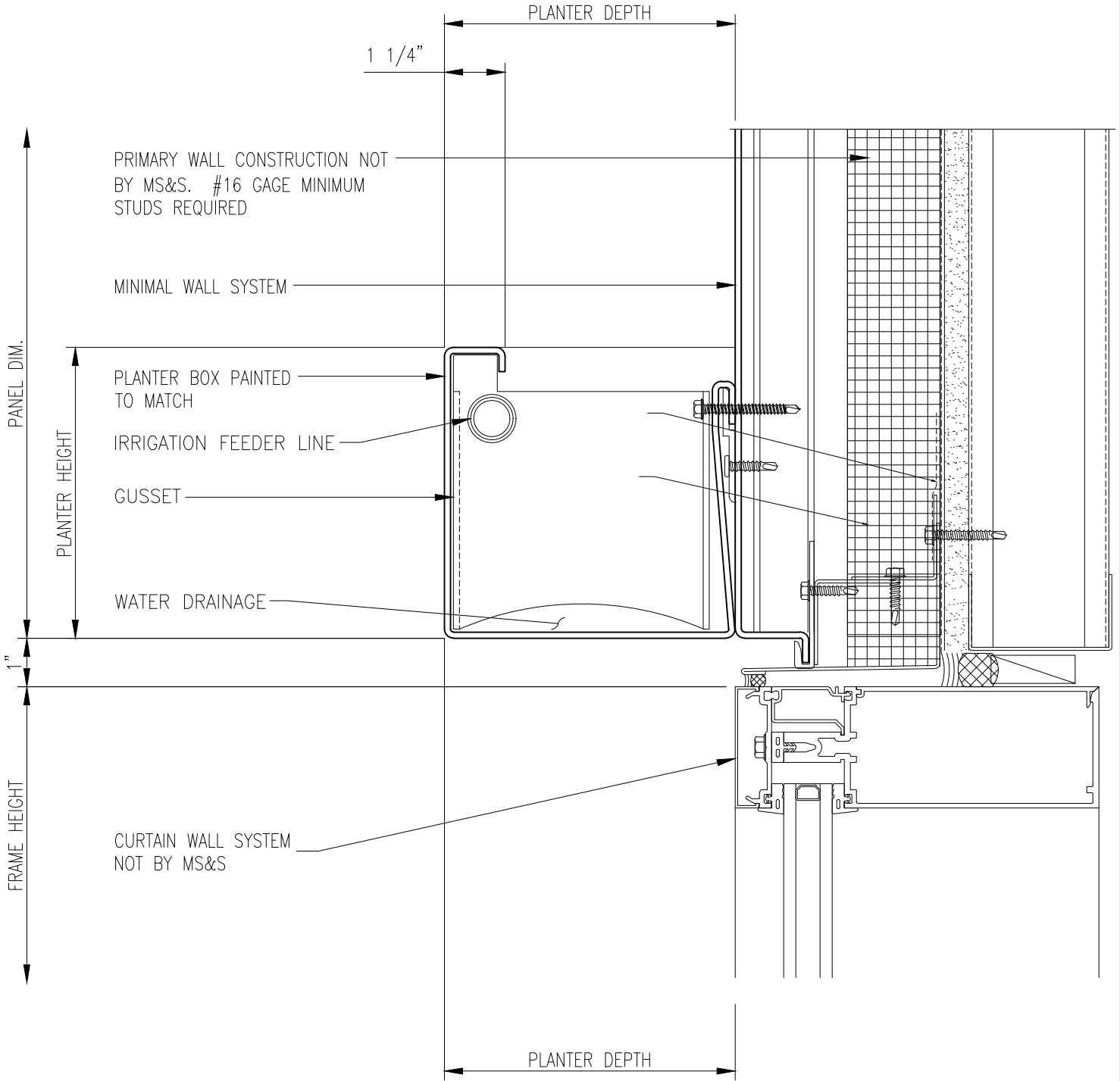

10) Curtain Wall Head

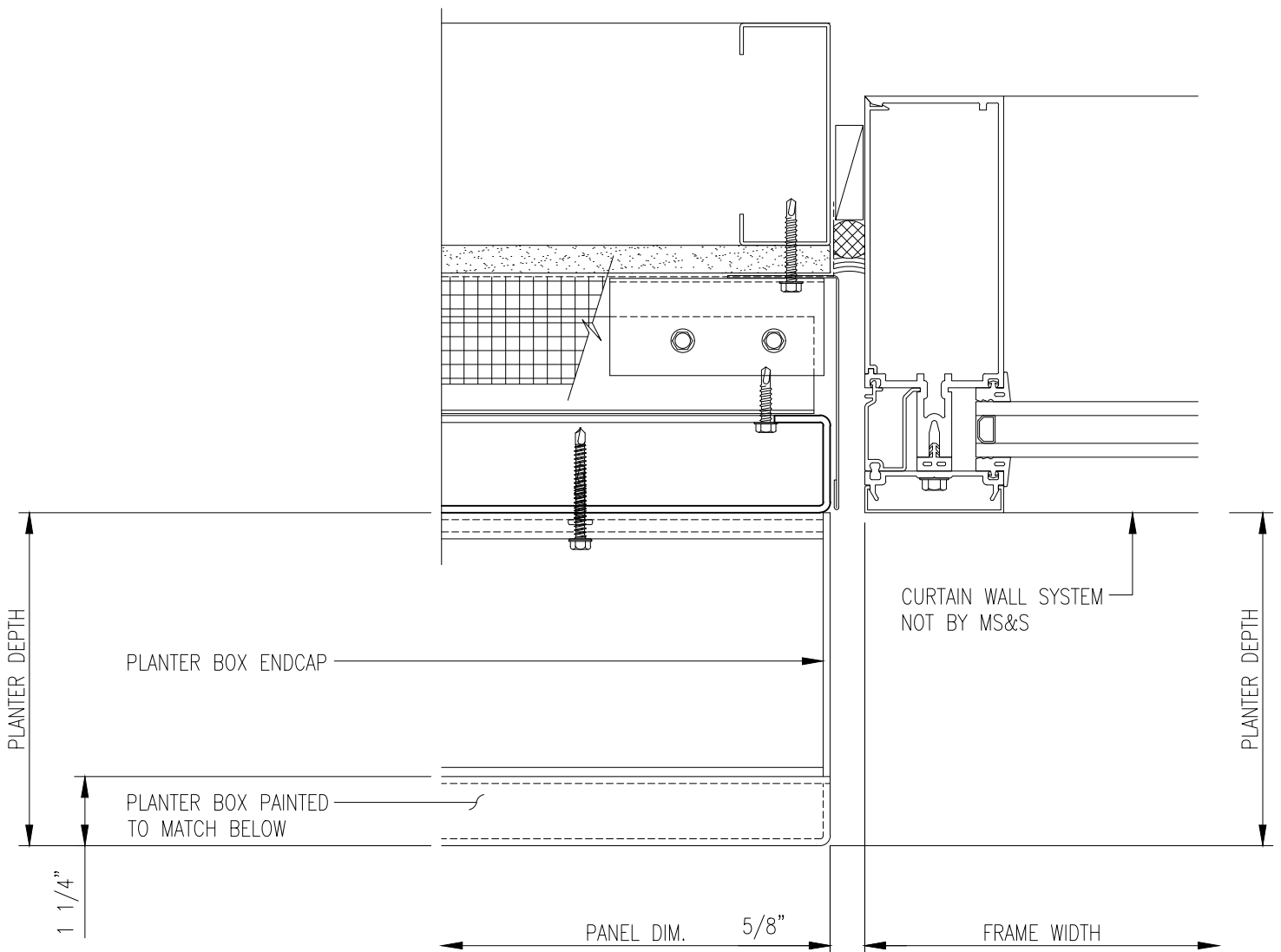

11) Curtain Wall Jamb

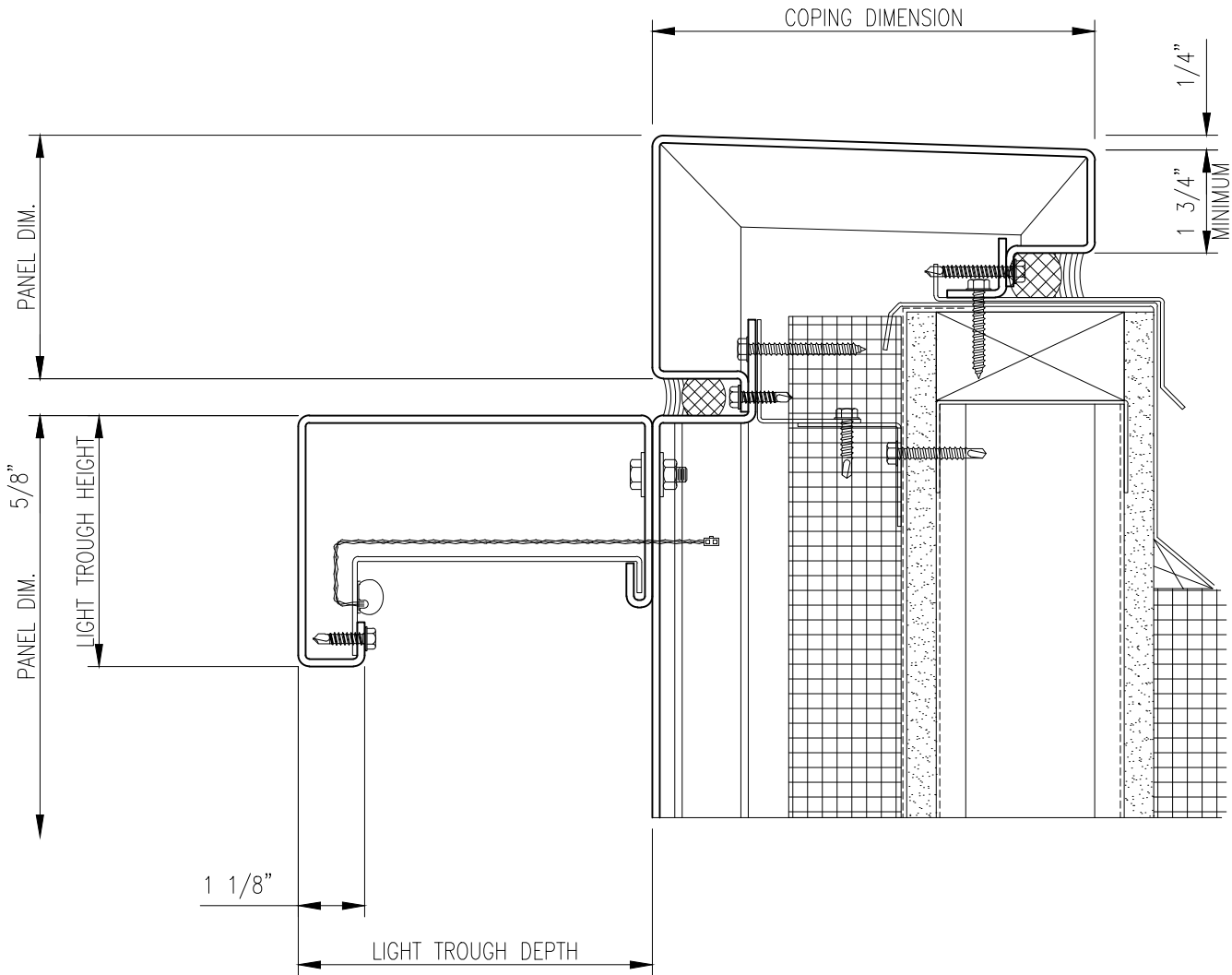

12) Coping

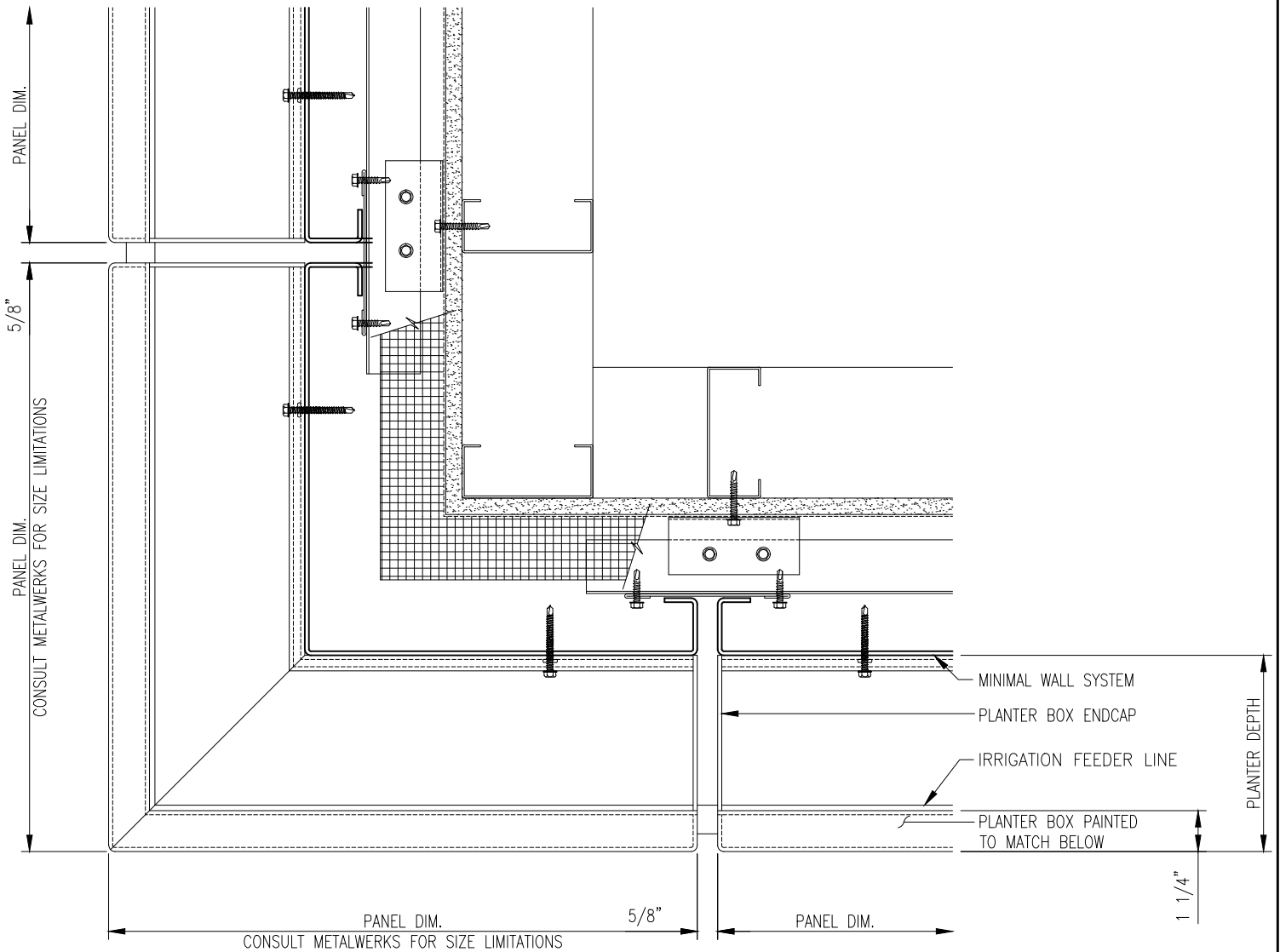

13) Outside Corner w/ Mitered Panel

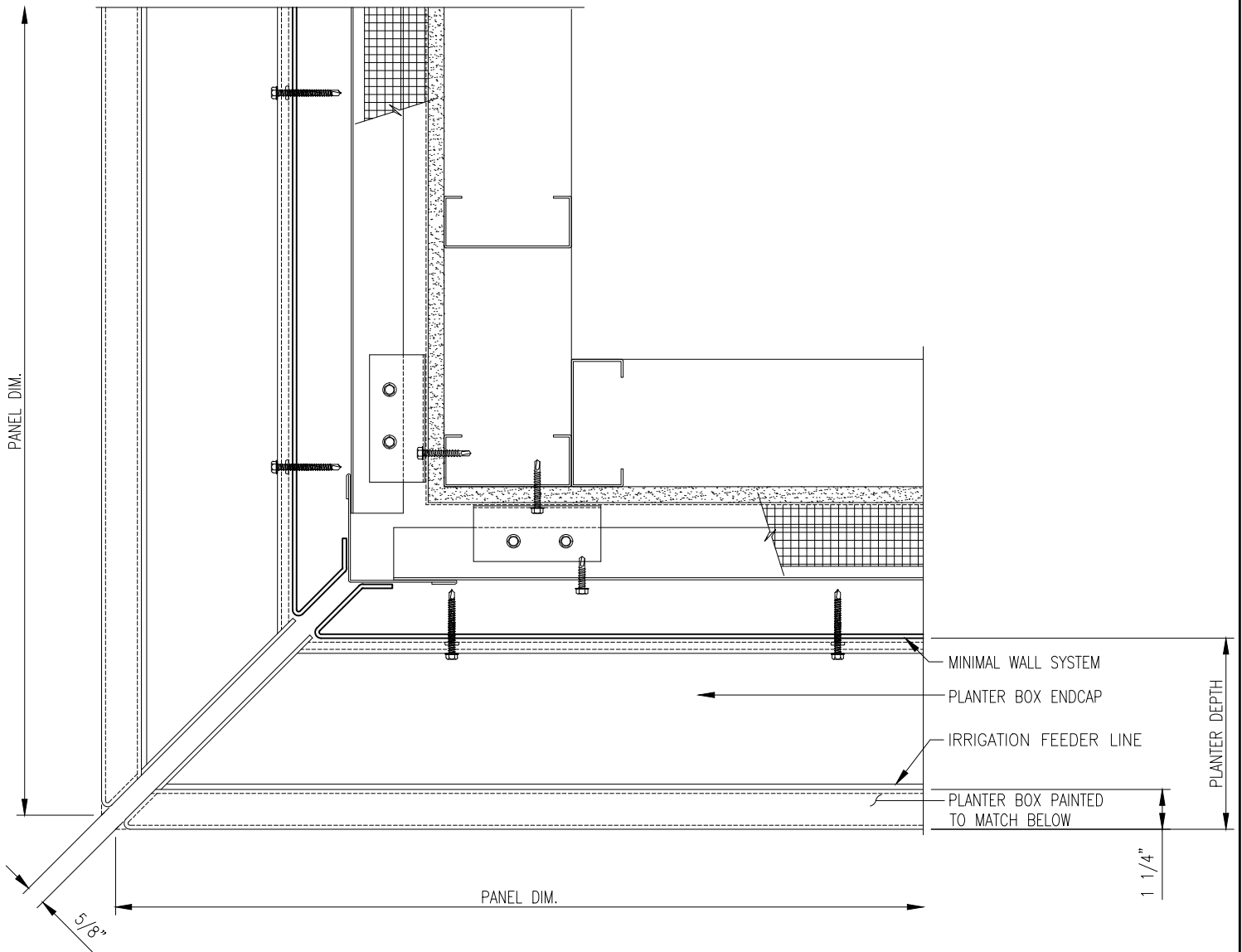

14) Outside Corner w/ Corner Reveal

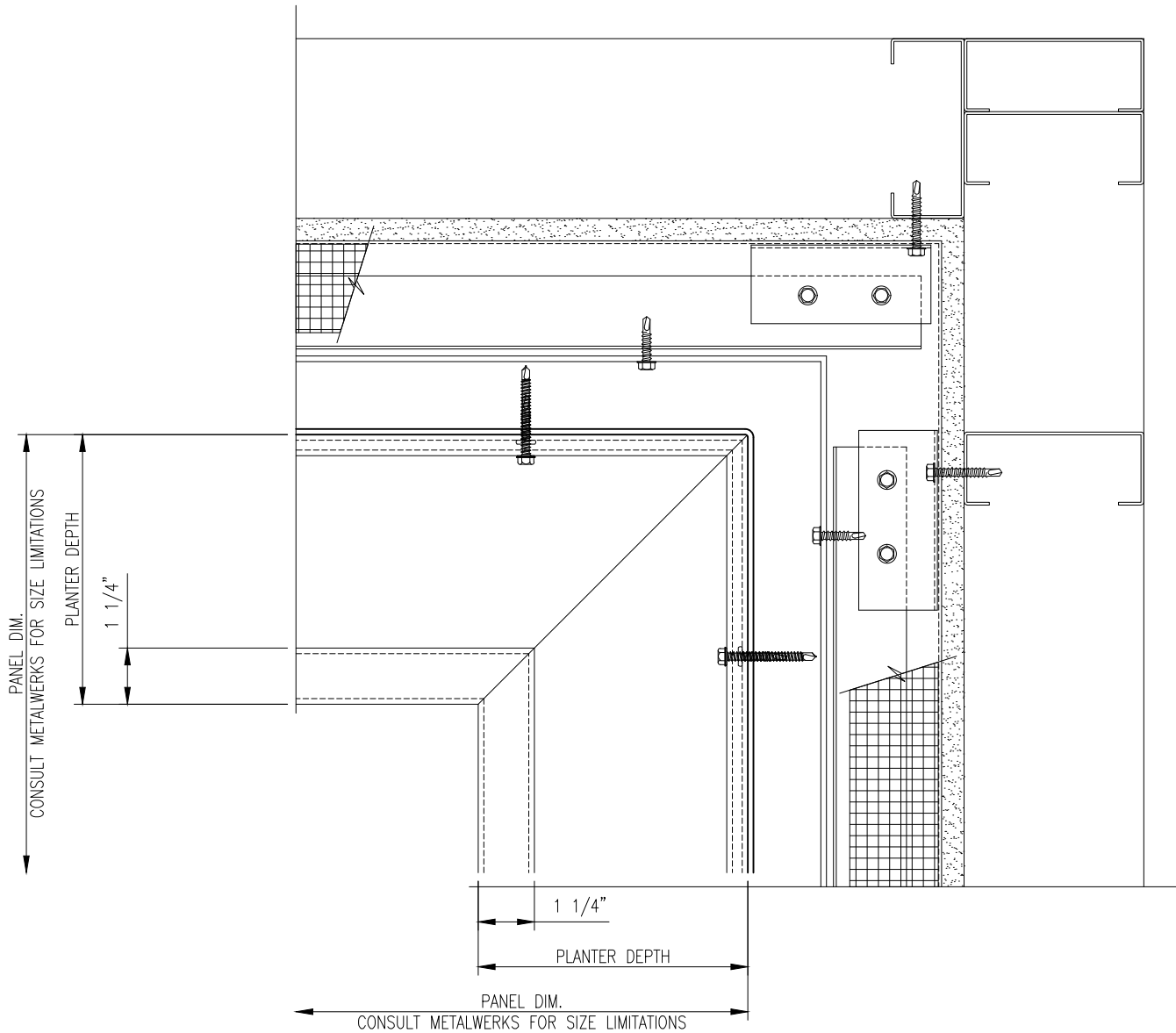

15) Inside Corner w/ Mitered Panel

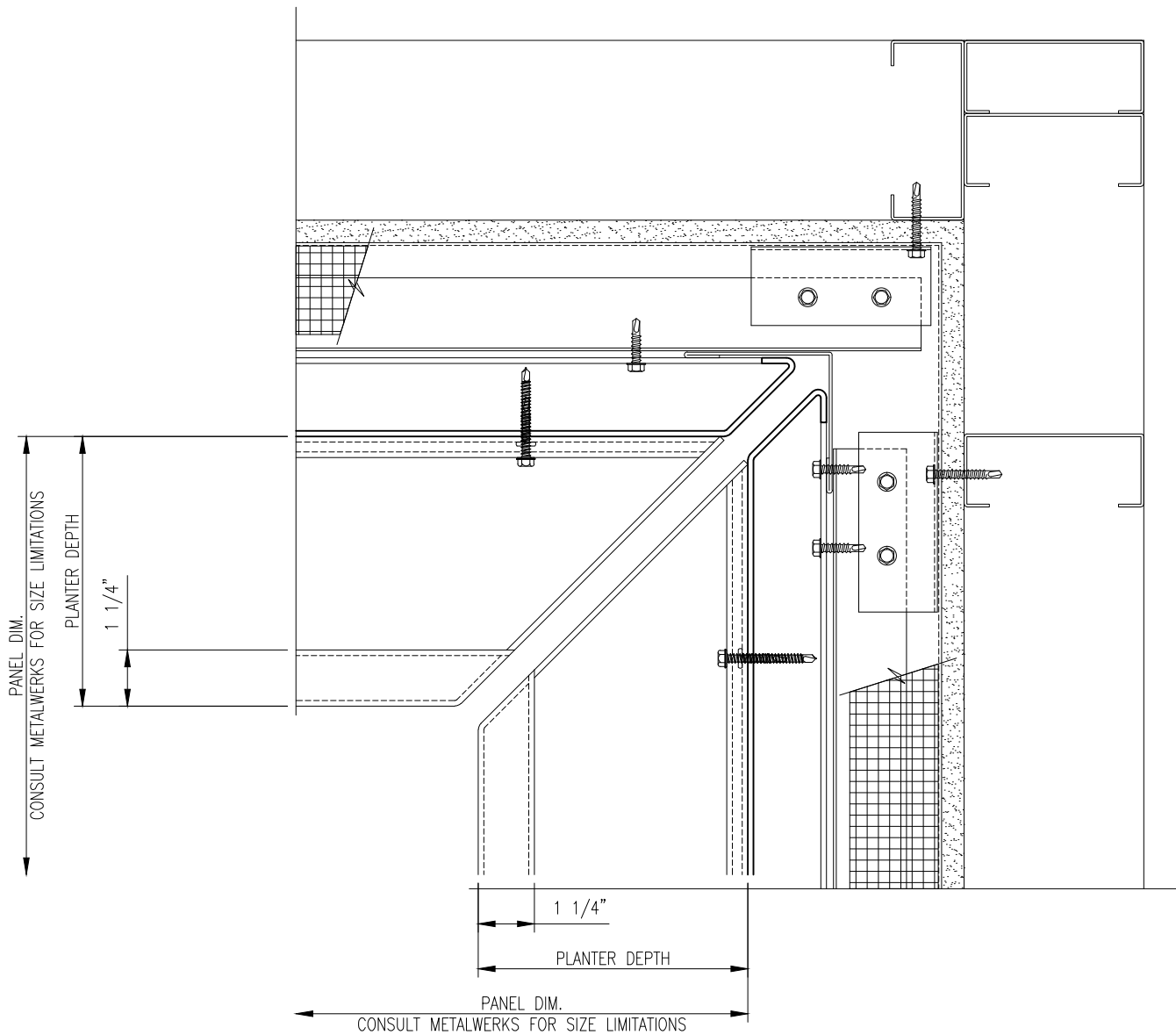

16) Inside Corner w/ Corner Reveal